



## Vimo S-UC

2.4G Dual-channel Mini Wireless Microphone

**User Manual**



## Foreword

Thanks for purchasing Comica 2.4G Dual-channel Mini Wireless Microphone Vimo S-UC.

## Features

- Mini and Lightweight, Unique Magnetic Integrated Microphone
- 48kHz/24bit Record, Broadcasting-level Sound Quality
- USB Digital Output, Universal for Computers and Phones
- Stepless Volume Adjustment, One-key Muting and Denoise
- USB-C Charging/Monitoring Port, Support Pass-through Phone Charging
- Support Monitoring with Zero-latency and Mono/Stereo Switch
- Rechargeable Storage Case for Charging, Storing and Power Monitoring
- Duration Up to 15 Hours, Support Using While Charging
- Low Latency < 20ms, Working Range Up to 200m(Open Area)

## Notice

- ⚠ Due to 2.4G wireless characteristics, please keep face to face when use it, and don't turn your back to the receiver, otherwise it is easy to generate breakpoints, which is a normal phenomenon.
- ⚠ Due to the characteristics of lithium batteries, the transmitter's charging indicator will show an inaccurate battery level when the charging starts, and the actual power may be lower than the indicated power. If the transmitter runs out of power, it will take more than two hours to get fully charged.
- ⚠ Please pay attention that it can not realize STEREO function when in single-channel mode.
- ⚠ Please do not expose the product to rain or moisture, and avoid having water or other liquids spilled on it.
- ⚠ Please do not use or store the product near any heat sources such as radiators, stoves, or other heat-producing appliances.
- ⚠ This product is a high-precision product, please prevent it from dropping or colliding.

## Packing List

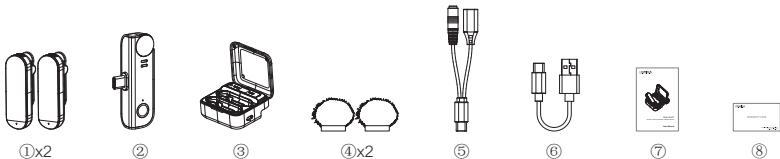

- ① Transmitter(TX)
- ② Receiver(RX)
- ③ Charging Case
- ④ Wind Muff
- ⑤ 2 in 1 Charging/Monitoring Adapter Cable
- ⑥ USB C-USB A Charging Cable
- ⑦ User Manual
- ⑧ Warranty Card

## Components and Instruction

### Transmitter (TX):

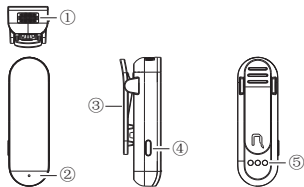

① Internal Mic

② Working Status Indicator:

Blink blue slowly when unpaired; Blink rapidly when pairing;  
Show blue when paired; Show green when denoise is on; Show red when muting.

③ Belt Clip

④ Mute/Denise/Pairing Switch Button:

Short press for muting; Long press for pairing when unpaired; Long press for denoise when paired.

⑤ Charging Contacts

## Receiver (RX):

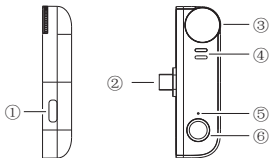

① Charging/Monitoring Port

② USB-C Plug

③ Transmitter Volume Control Knob:

Adjust the volume of transmitter 1/2 synchronously. Turn counterclockwise to increase the volume, and turn clockwise to reduce the volume.

④ Transmitter 1/2 Pairing Indicator:

Blink blue when unpaired; Show blue when paired.

⑤ Mode Indicator:

Show blue when in mono mode; Indicator is off when in stereo mode.

⑥ Mono/Stereo Switch Button:

Short press to switch Mono/Stereo mode.

## Charging Case:

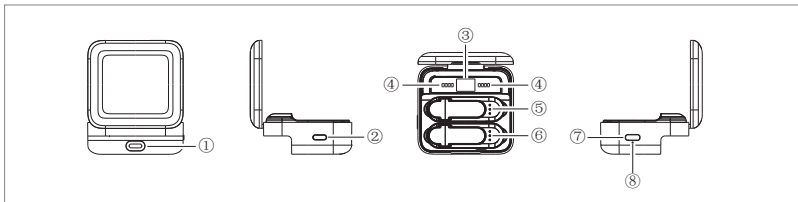

① USB-C Port

② Battery Level Indicator Button:

Short press to show the battery level of charging case and transmitters.

③ Charging Case Battery Level: 0-100

④ Battery Level Indicator of Transmitters:

The left indicators show the battery level of the transmitter placed in the charger well 1;

The right indicators show the battery level of the transmitter placed in the charger well 2.

There are four power indicator lights, one of which represents 25% of the power.

⑤ Charger Well 1

⑥ Charger Well 2

⑦ USB-C Charging Port

⑧ Restoration Hole



## Installation and Usage

**Pairing** (All have been paired at the factory. If you need to re-pair, please follow the steps below.)

Long press the pairing button on the TX to pair. The indicator lights on the TX and the RX will show blue when the pairing is successful.

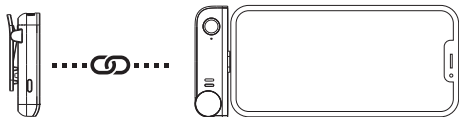

## Usage

### 1. Remove the transmitters and the receiver from the charging case

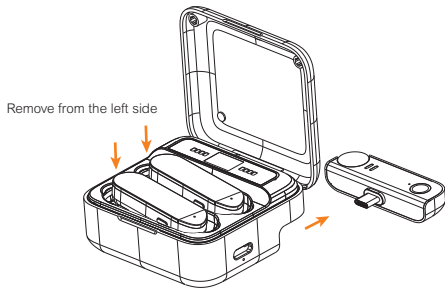

## 2. Install the transmitter on the collar

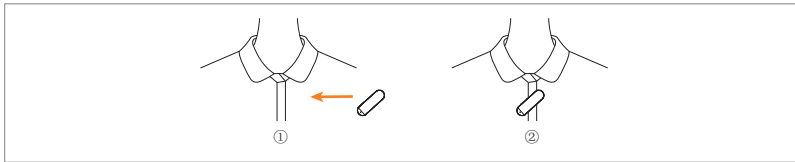

Install the transmitter on the collar so that the internal mic points to the sound source

## 3. Attach the receiver to the USB-C devices (phones and computers)

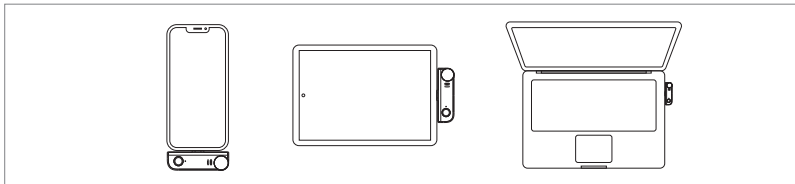

## 4. Monitoring/Charging

### Method One

Connect USB-C headphones to monitor or connect the power bank/DC power using the USB C-USB A charging cable to charge the mobile phone.

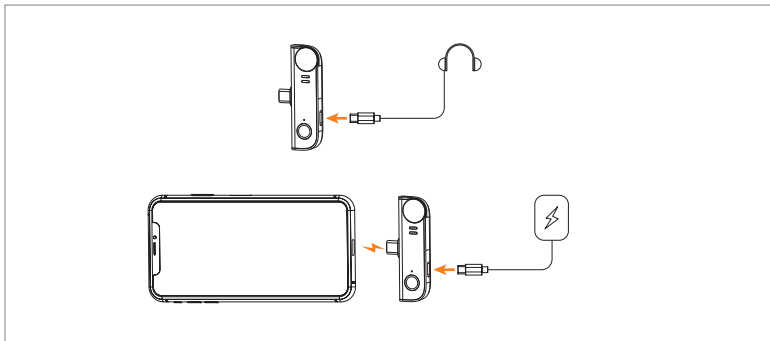

## Method Two

Connect 3.5mm headphones through the 2 in 1 charging/monitoring adapter cable for monitoring and connect the power bank/DC power to charge the mobile phone at the same time.

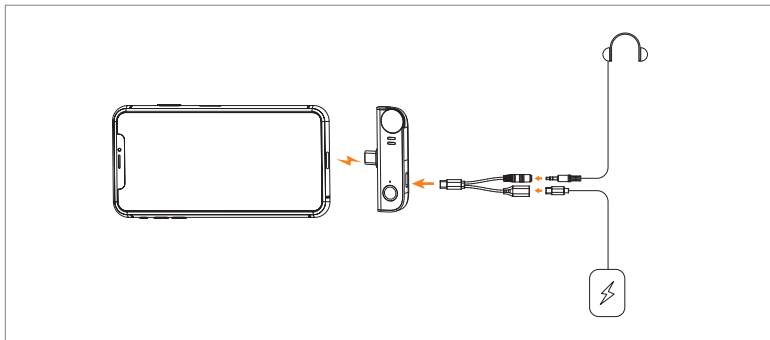

## Specification

Wireless Type	2.4GHz
Antenna	Built-in Antenna
Sampling Rate	48kHz
Bit Depth	24bits
Transmitting Power	10dBm
Sensitivity	-32dB $\pm$ 2dB
Polar Pattern	Omnidirectional
Frequency Response	80Hz~20kHz
S/N	70dB
Equivalent Noise	24dBA
Maximum SPL	110dB
Dynamic Range	86dB
Sound Delay	<20ms
Battery	TX: Built-in Li-ion Battery 95mAh 3.8V Charging Case: Built-in Li-ion Battery 800mAh 3.8V
Charging Time	TX: 2 Hours; Charging Case: 2 Hours
Standby Time	TX: 5 Hours; Charging Case: 2 times for two transmitters and one receiver charged simultaneously
Net Weight	TX: 10g RX: 12g Charging Case: 53g
Dimension	TX: 16x16x50mm RX: 12x26.5x63mm Charging Case: 29x58.5x63mm
Operating Temperature	0 C ~ 50 C
Storage Temperature	-20 C ~ 60 C



**Vimo S-UC**

2.4G双通道迷你无线麦克风

产品使用说明书





## 前言

感谢您购买科唛Vimo S-UC

## 产品主要功能

- 独特磁吸集成化设计，轻巧迷你
- 48kHz/24bit录音，超CD级音质
- USB直插式数字输出，广泛兼容手机、电脑等设备
- 无级音量可调，支持一键静音及降噪
- USB-C充电/监听接口，支持手机直通充电
- 支持实时监听，单声道/立体声切换
- 多功能磁吸充电盒，总续航高达15小时
- 低音频延迟 < 20ms，无线传输距离高达200m

## 注意事项

- ⚠ 由于2.4G无线特性，使用时尽量保持面对面，避免背对的情况，否则容易产生断点，属正常现象
- ⚠ 由于锂电池的特性，发射器充电开始时存在虚电现象，实际电量可能会低于显示电量。若电量完全耗尽，需要充电两小时以上才能充满
- ⚠ 单通道模式下，立体声（STEREO）功能无法实现
- ⚠ 请将该产品放置在干燥环境中保存；请勿在雨中或潮湿的环境中使用该设备，以免发生短路
- ⚠ 请勿将产品放置在散热器、烤箱、冰箱、空调等热源或干扰源附近使用
- ⚠ 本产品属于高精密仪器类产品，请勿掉落、碰撞或撞击产品

## 包装清单



①x2

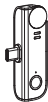

②



③



④x2



⑤



⑥



⑦



⑧

- ① 发射器(TX)
- ② 接收器(RX)
- ③ 充电盒
- ④ 防风毛
- ⑤ 一分二音频/充电转接线
- ⑥ USB C-USB A充电线
- ⑦ 说明书
- ⑧ 保修卡

## 部件介绍及说明

### 发射器(TX):

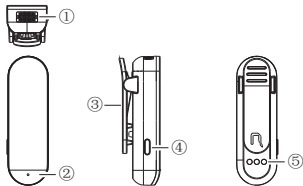

① 内置咪头

② 工作状态指示灯:

未配对时蓝灯慢闪; 配对时指示灯快闪; 配对成功时蓝灯长亮; 开启降噪时绿灯长亮; MIC静音时红灯长亮。

③ 背夹

④ 静音/降噪/配对切换按键:

短按静音; 未配对时长按配对; 已配对时长按降噪。

⑤ 充电触点

## 接收器(RX):

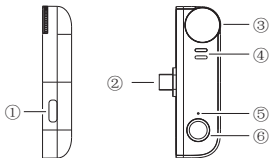

① 充电/监听接口

② USB-C插头

③ 发射器音量调节旋钮:

同时调节发射器1和2的音量, 逆时针调节增大音量, 顺时针调节减小音量。

④ 发射器1/2配对指示灯:

未配对时蓝灯闪烁; 配对成功蓝灯长亮。

⑤ 模式指示灯:

单声道模式下, 蓝灯长亮; 立体声模式下, 指示灯不亮。

⑥ 单声道/立体声切换按键:

短按切换单声道/立体声。

## 充电盒:

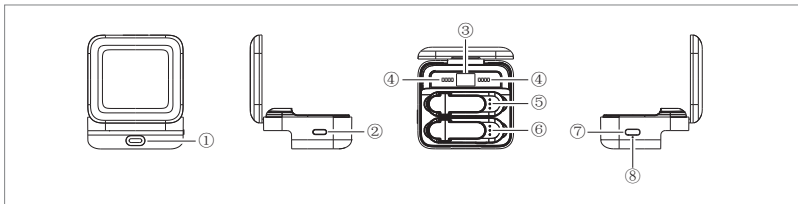

① USB-C插口

② 唤醒按键:

短按显示充电盒及发射器的电量。

③ 充电盒电量:

电量显示为0~100。

④ 发射器电量:

左侧显示充电槽1中发射器的电量；右侧显示充电槽2中发射器的电量；总共有四格电量，每格代表25%电量。

⑤ 充电槽1

⑥ 充电槽2

⑦ 充电盒USB-C充电插口

⑧ 充电盒复位孔

## 安装与使用方法

**配对**（出厂时均已配对，如需重新配对可按如下方式操作）

长按发射器配对按钮进行配对，配对成功后发射器，接收器的蓝灯长亮

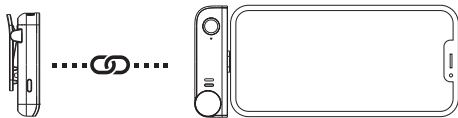

## 使用方法

### 1. 按照图示取出发射器和接收器

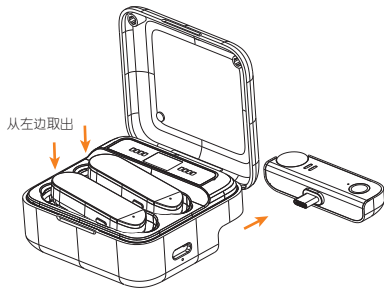

## 2. 将发射器安装在衣领上

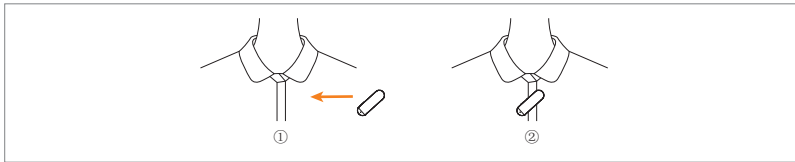

将发射器安装到衣领上，使内置麦克风指向音源方向

## 3. 将接收器接入USB-C设备

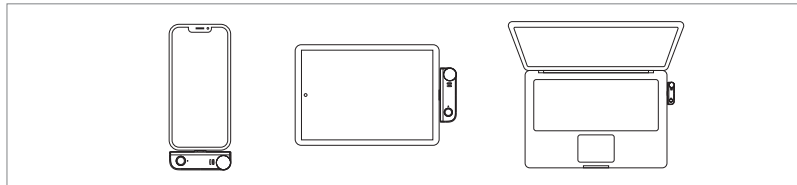



#### 4. 监听/充电

##### 方法一

连接USB-C耳机进行实时监听，或连接充电宝/DC电源给手机充电

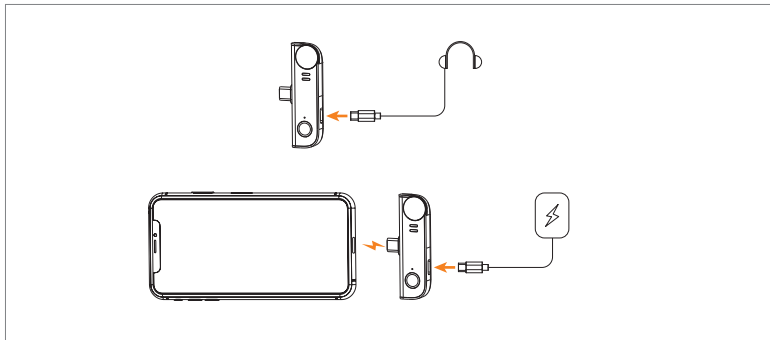

## 方法二

通过一分二音频/充电转接线连接3.5mm耳机进行实时监听, 同时连接充电宝/DC电源给手机充电

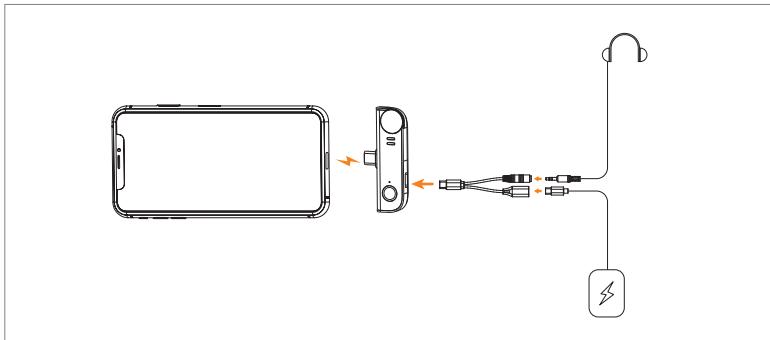

## 规格参数

无线类型	2.4GHz
天线	内置天线
采样率	48kHz
位深	24bits
发射功率	10dBm
麦克风灵敏度	-32dB±2dB
麦克风指向性	全指向
麦克风频率响应	80Hz ~ 20kHz
系统信噪比	70dB
系统等效噪声	24dBA
最大声压级	110dB
动态范围	86dB
声音延迟	<20ms
电池类型	TX: 锂聚合物 95mAh 3.8V 充电盒: 锂聚合物 800mAh 3.8V
充电时间	TX: 2小时; 充电盒: 2小时
续航时间	TX: 5小时; 充电盒: 2次
净重	TX: 10g RX: 12g 充电盒: 53g
尺寸	TX: 16x16x50mm RX: 12x26.5x63mm 充电盒: 29x58.5x63mm
工作温度	0°C ~ 50°C
存储温度	-20°C ~ 60°C



Website: [comica-audio.com](http://comica-audio.com)

Facebook: Comica Audio Tech Global

Instagram: Comica Audio

YouTube: Comica Audio

The COMICA LOGO is a trademark which is registered and owned by Commlite Technology Co.,Ltd

Email: [support@comica-audio.com](mailto:support@comica-audio.com)